

Surface Mount Varistors

Multilayer Transient Voltage Surge Suppressors

RoHS ML Varistor Series

The ML Series family of Transient Voltage Surge Suppression devices is based on the Littelfuse Multilayer fabrication technology. These components are designed to suppress a variety of transient events, including those specified in IEC 61000-4-2 or other standards used for Electromagnetic Compliance (EMC). The ML Series is typically applied to protect integrated circuits and other components at the circuit board level.

The wide operating voltage and energy range make the ML Series suitable for numerous applications on power supply, control and signal lines.

The ML Series is manufactured from semiconducting ceramics, and is supplied in a leadless, surface mount package. The ML Series is compatible with modern reflow and wave soldering procedures.

It can operate over a wider temperature range than zener diodes, and has a much smaller footprint than plastic-housed components.

Littelfuse Inc. manufactures other Multilayer Series products. See the MLE Series data sheet for ESD applications, MHS Series data sheet for high-speed ESD applications, the MLN for multiline protection and the AUML Series for automotive applications.

Features

- RoHS Compliant
- Leadless 0402, 0603, 0805, 1206 and 1210 Chip Sizes
- Multilayer Ceramic Construction Technology
- -55°C to +125°C Operating Temperature Range
- Operating Voltage Range $V_{M(DC)} = 5.5V$ to 120V
- Rated for Surge Current (8 x 20µs)
- Rated for Energy (10 x 1000µs)
- Inherent Bi-directional Clamping
- No Plastic or Epoxy Packaging Assures Better than 94V-0 Flammability Rating
- Standard Low Capacitance Types Available

Applications

- Suppression of Inductive Switching or Other Transient Events Such as EFT and Surge Voltage at the Circuit Board Level
- ESD Protection for Components Sensitive to IEC 61000-4-2, MIL-STD-883C Method 3015.7, and Other Industry Specifications (See Also the MLE or MLN Series)
- Provides On-Board Transient Voltage Protection for ICs and Transistors
- Used to Help Achieve Electromagnetic Compliance of End Products
- Replace Larger Surface Mount TVS Zeners in Many Applications



Size

Metric	EIA
1005	0402
1608	0603
2012	0805
3216	1206
3225	1210
4532	1812
5650	2220

Surface Mount Varistors

Multilayer Transient Voltage Surge Suppressors

RoHS ML Varistor Series

Absolute Maximum Ratings For ratings of individual members of a series, see Device Ratings and Specifications table.

Continuous:

Steady State Applied Voltage:

DC Voltage Range ($V_{M(DC)}$) 3.5 to 120

AC Voltage Range ($V_{M(AC)(RMS)}$) 2.5 to 107

Transient:

Non-Repetitive Surge Current, 8/20 μ s Waveform, (I_{TM}) 4 to 500

Non-Repetitive Surge Energy, 10/1000 μ s Waveform, (W_{TM}) 0.02 to 1.2

Operating Ambient Temperature Range (T_A) -55 to + 125

Storage Temperature Range (T_{STG}) -55 to + 150

Temperature Coefficient ($\square V$) of Clamping Voltage (V_C) at Specified Test Current <0.01

ML SERIES UNITS

V

V

A

J

°C

°C

%/°C

Device Ratings and Specifications

PART NUMBER	MAXIMUM RATINGS (125°C)					SPECIFICATIONS (25°C)		
	MAXIMUM CONTINUOUS WORKING VOLTAGE		MAXIMUM NON-REPETITIVE SURGE CURRENT (8/20 μ s)	MAXIMUM NON-REPETITIVE SURGE ENERGY (10/1000 μ s)	MAXIMUM CLAMPING VOLTAGE AT 1A (OR AS NOTED) (8/20 μ s)	NOMINAL VOLTAGE AT 1mA DC TEST CURRENT		TYPICAL CAPACITANCE AT f = 1MHz
	$V_{M(DC)}$	$V_{M(AC)}$	I_{TM}	W_{TM}	V_C	$V_{N(DC) MIN}$	$V_{N(DC) MAX}$	C
	(V)	(V)	(A)	(J)	(V)	(V)	(V)	(pF)
V3.5MLA0603	3.5	2.5	30	0.1	13	3.7	7.0	1270
V3.5MLA0805	3.5	2.5	120	0.3	13	3.7	7.0	2530
V3.5MLA0805L	3.5	2.5	40	0.1	13	3.7	7.0	1380
V3.5MLA1206	3.5	2.5	100	0.3	13	3.7	7.0	6000
V5.5MLA0402	5.5	4.0	20	0.050	19	7.1	10.8	220
V5.5MLA0402L	5.5	4.0	20	0.050	38	15.9	21.5	70
V5.5MLA0603	5.5	4.0	30	0.1	17.5	7.1	9.3	760
V5.5MLA0805	5.5	4.0	120	0.3	17.5	7.1	9.3	1840
V5.5MLA0805L	5.5	4.0	40	0.1	17.5	7.1	9.3	990
V5.5MLA1206	5.5	4.0	150	0.4	17.5	7.1	9.3	5180
V9MLA0402	9	6.5	20	0.050	30	11	16	120
V9MLA0402L	9	6.5	4	0.020	35	11	16	33
V9MLA0603	9.0	6.5	30	0.1	25.5	11	16	490
V9MLA0805L	9.0	6.5	40	0.1	25.5	11	16	520
V12MLA0805L	12	9.0	40	0.1	29	14	18.5	410
V14MLA0402	14	10	20	0.050	38	15.9	21.5	70
V14MLA0603	14	10	30	0.1	34.5	15.9	21.5	180
V14MLA0805	14	10	120	0.3	32	15.9	20.3	560
V14MLA0805L	14	10	40	0.1	32	15.9	20.3	320
V14MLA1206	14	10	150	0.4	32	15.9	20.3	1840

3
SURFACE MOUNT
VARISTORS

Surface Mount Varistors

Multilayer Transient Voltage Surge Suppressors

RoHS ML Varistor Series

Device Ratings and Specifications (Continued)

PART NUMBER	MAXIMUM RATINGS (125°C)					SPECIFICATIONS (25°C)		
	MAXIMUM CONTINUOUS WORKING VOLTAGE		MAXIMUM NON-REPETITIVE SURGE CURRENT (8/20μs)	MAXIMUM NON-REPETITIVE SURGE ENERGY (10/1000μs)	MAXIMUM CLAMPING VOLTAGE AT 1A (OR AS NOTED) (8/20μs)	NOMINAL VOLTAGE AT 1mA DC TEST CURRENT		TYPICAL CAPACITANCE AT f = 1MHz
	V _{M(DC)} (V)	V _{M(AC)} (V)	I _{TM} (A)	W _{TM} (J)	V _C (V)	V _{N(DC)} MIN (V)	V _{N(DC)} MAX (V)	C (pF)
V18MLA0402	18	14	20	0.050	50	22	28.0	40
V18MLA0603	18	14	30	0.1	50	22	28.0	120
V18MLA0805	18	14	120	0.3	44	22	28.0	520
V18MLA0805L	18	14	40	0.1	44	22	28.0	290
V18MLA1206	18	14	150	0.4	44	22	28.0	1270
V18MLA1210	18	14	500	2.5	44 at 2.5A	22	28.0	1440
V26MLA0603	26	20	30	0.1	60	31	38	110
V26MLA0805	26	20	100	0.3	60	29.5	38.5	220
V26MLA0805L	26	20	40	0.1	60	29.5	38.5	140
V26MLA1206	26	20	150	0.6	60	29.5	38.5	1040
V26MLA1210	26	20	300	1.2	60 at 2.5A	29.5	38.5	1040
V30MLA0603	30	25	30	0.1	74	37	46	90
V30MLA0805L	30	25	30	0.1	72	37	46	90
V30MLA1210	30	25	280	1.2	68 at 2.5A	35	43	1820
V30MLA1210L	30	25	220	0.9	68 at 2.5A	35	43	1760
V33MLA1206	33	26	180	0.8	75	38	49	640
V42MLA1206	42	30	180	0.8	92	46	60	640
V48MLA1210	48	40	250	1.2	105 at 2.5A	54.5	66.5	520
V48MLA1210L	48	40	220	0.9	105 at 2.5A	54.5	66.5	500
V56MLA1206	56	40	180	1.0	120	61	77	180
V60MLA1210	60	50	250	1.5	130 at 2.5A	67	83	440
V68MLA1206	68	50	180	1.0	140	76	90	180
V85MLA1210	85	67	250	2.5	180 at 2.5A	95	115	260
V120MLA1210	120	107	125	2.0	260 at 2.5A	135	165	80

NOTES:

1. L suffix is a low capacitance and energy version; Contact your Littelfuse Sales Representative for custom capacitance requirements.
2. Typical leakage at 25°C < 25A, maximum leakage 100A at V_{M(DC)}; for 0402 size, typical leakage < 5A, maximum leakage < 20A at V_{M(DC)}.
3. Average power dissipation of transients for 0402, 0603, 0805, 1206 and 1210 sizes not to exceed 0.03W, 0.05W, 0.1W, 0.1W and 0.15W respectively.

Surface Mount Varistors

Multilayer Transient Voltage Surge Suppressors

RoHS ML Varistor Series

Temperature De-rating

When transients occur in rapid succession, the average power dissipation is the energy (watt-seconds) per pulse times the number of pulses per second. The power so developed must be within the specifications shown on the Device Ratings and Specifications table for the specific device. For applications exceeding 125°C ambient temperature, the peak surge current and energy ratings must be derated as shown in Figure 1.

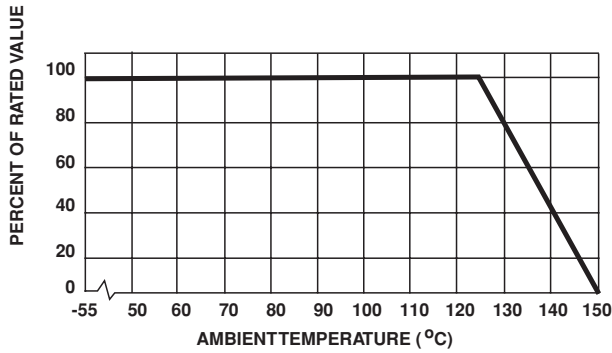

FIGURE 1. PEAK CURRENT AND ENERGY DERATING CURVE

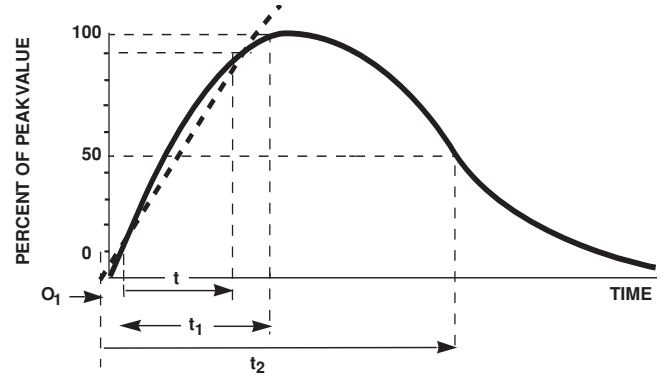

FIGURE 2. PEAK PULSE CURRENT TEST WAVEFORM FOR CLAMPING VOLTAGE

O_1 = VIRTUAL ORIGIN OF WAVE
 t = TIME FROM 10% TO 90% OF PEAK
 t_1 = VIRTUAL FRONT TIME = $1.25 \times t$
 t_2 = VIRTUAL TIME TO HALFVALUE (IMPULSE DURATION)

EXAMPLE:
 FOR AN $8/20\mu\text{s}$ CURRENT WAVEFORM
 $8\mu\text{s} = t_1$ = VIRTUAL FRONT TIME
 $20\mu\text{s} = t_2$ = VIRTUAL TIME TO HALFVALUE

MLA0402 Limit VI Curves

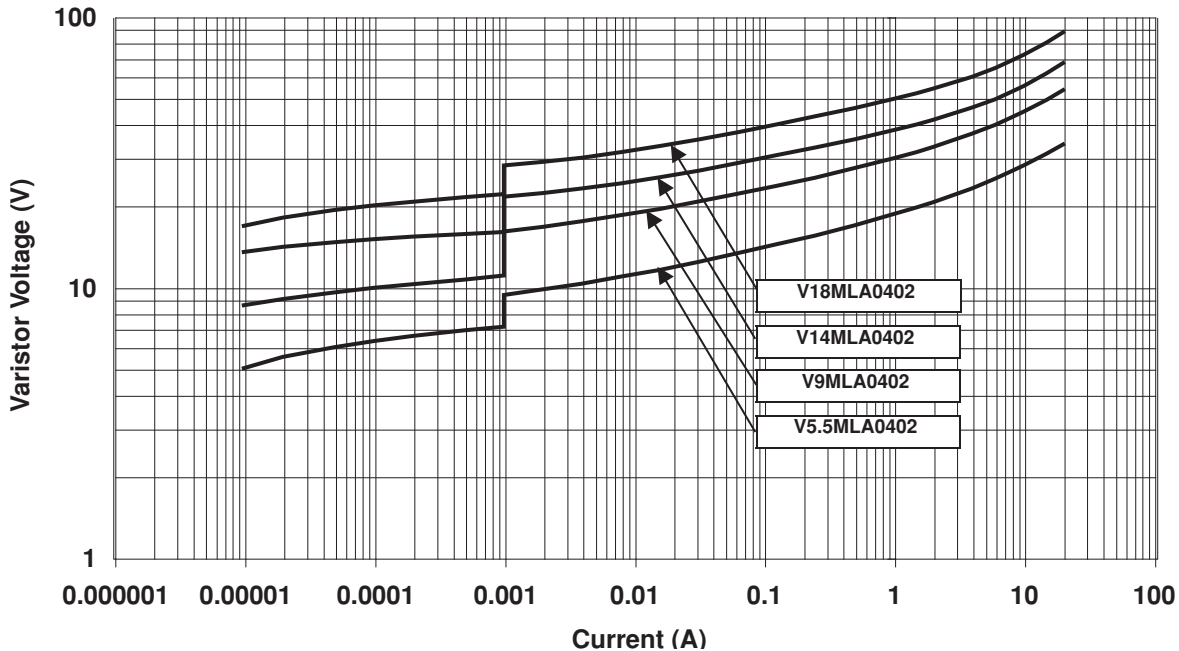

FIGURE 3. LIMIT V-I CHARACTERISTIC FOR V5.5MLA0402 TO V18MLA0402

Surface Mount Varistors

Multilayer Transient Voltage Surge Suppressors

RoHS ML Varistor Series

Maximum Transient V-I Characteristic Curves

MLA0402L Limit VI Curves

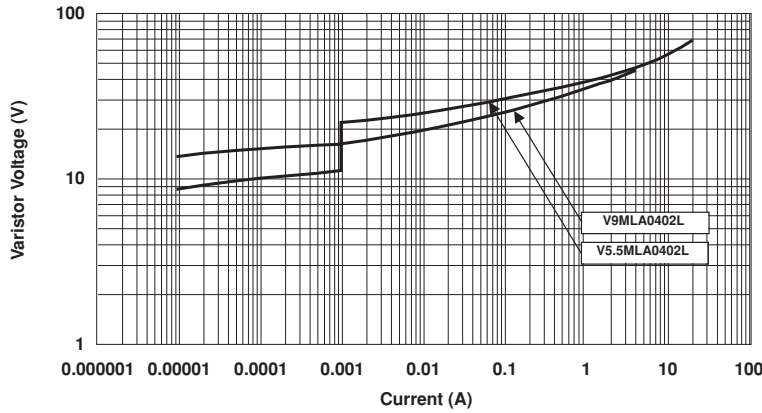

FIGURE 4. LIMIT V-I CHARACTERISTIC FOR V9MLA0402L

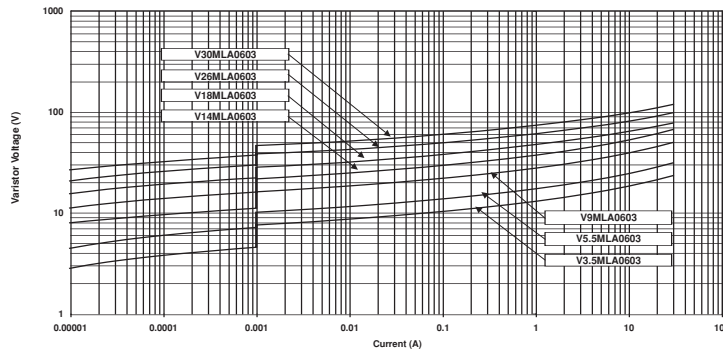

FIGURE 5. LIMIT V-I CHARACTERISTIC FOR V3.5MLA0603 TO V30MLA0603

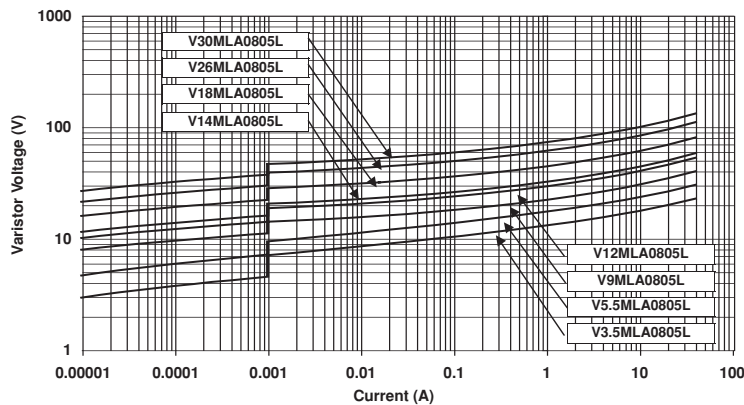

FIGURE 6. LIMIT V-I CHARACTERISTIC FOR V3.5MLA0805L TO V30MLA0805L

Surface Mount Varistors

Multilayer Transient Voltage Surge Suppressors

RoHS ML Varistor Series

Maximum Transient V-I Characteristic Curves (Continued)

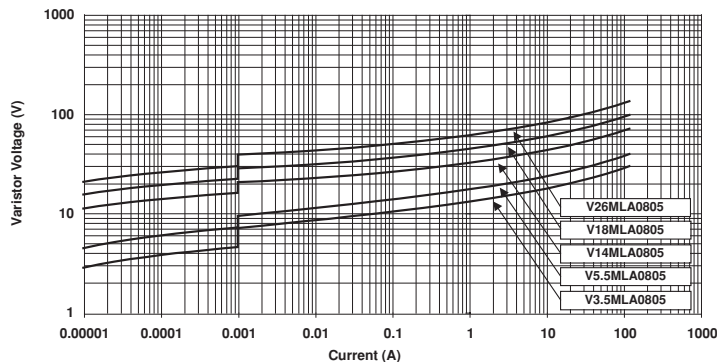

FIGURE 7. LIMIT V-I CHARACTERISTIC FOR V3.5MLA0805 TO V26MLA0805

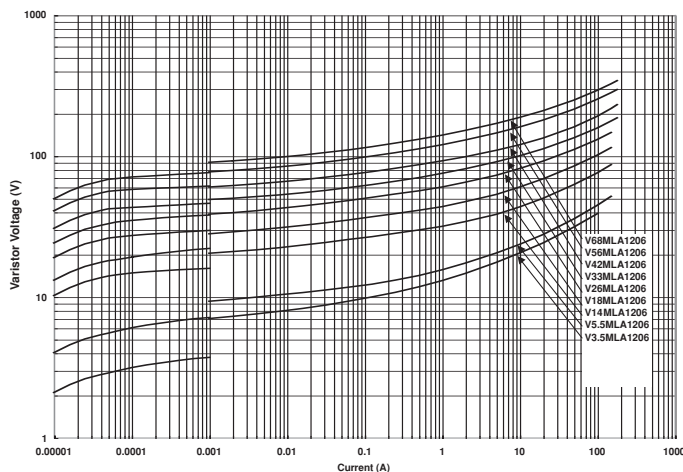

FIGURE 6. LIMIT V-I CHARACTERISTIC FOR V3.5MLA1206 TO V68MLA1206

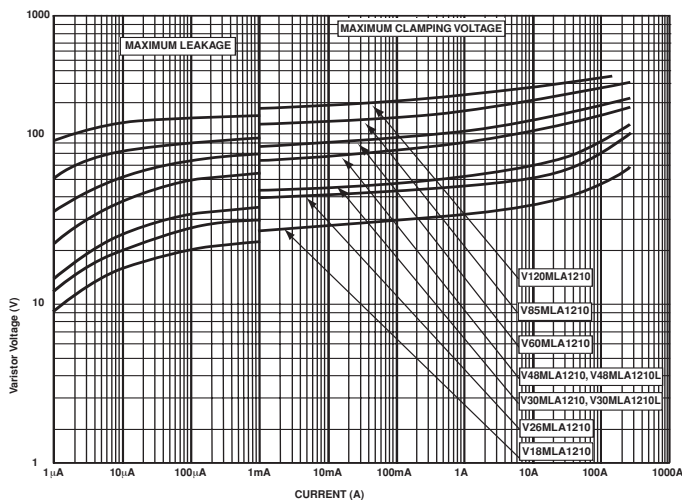

FIGURE 9. LIMIT V-I CHARACTERISTIC FOR V18MLA1210 TO V120MLA1210

Surface Mount Varistors

Multilayer Transient Voltage Surge Suppressors

RoHS ML Varistor Series

Device Characteristics

At low current levels, the V-I curve of the multilayer transient voltage suppressor approaches a linear (ohmic) relationship and shows a temperature dependent effect (Figure 10). At or below the maximum working voltage, the suppressor is in a high resistance mode (approaching $10^9\Omega$ at its maximum rated working voltage). Leakage currents at maximum rated voltage are below $50\mu\text{A}$, typically $25\mu\text{A}$; for 0402 size below $10\mu\text{A}$, typically $5\mu\text{A}$.

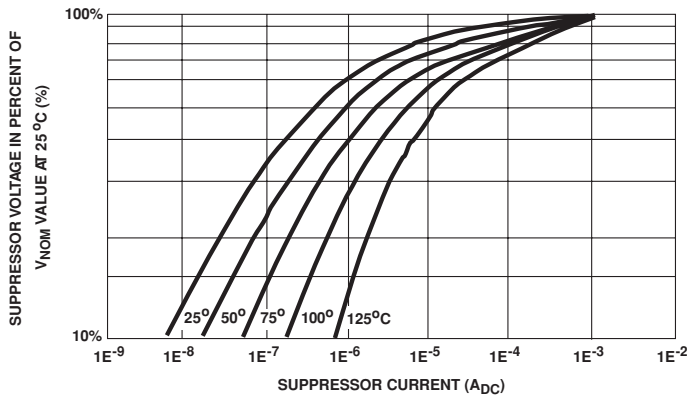

FIGURE 10. TYPICAL TEMPERATURE DEPENDENCE OF THE CHARACTERISTIC CURVE IN THE LEAKAGE REGION

Speed of Response

The Multilayer Suppressor is a leadless device. Its response time is not limited by the parasitic lead inductances found in other surface mount packages. The response time of the Zinc Oxide dielectric material is less than 1 nanosecond and the ML can clamp very fast dV/dT events such as ESD. Additionally, in “real world” applications, the associated circuit wiring is often the greatest factor effecting speed of response. Therefore, transient suppressor placement within a circuit can be considered important in certain instances.

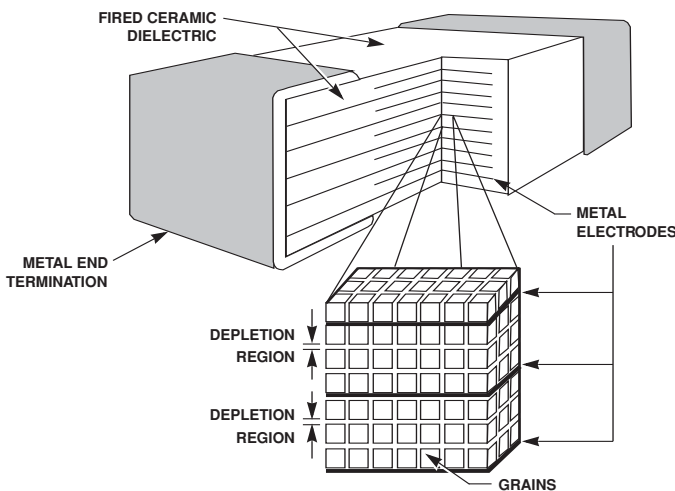

FIGURE 11. MULTILAYER INTERNAL CONSTRUCTION

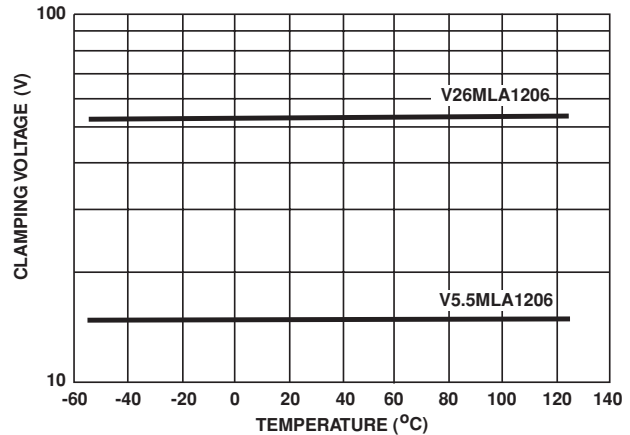

FIGURE 12. CLAMPING VOLTAGE OVER TEMPERATURE (V_C AT 10A)

Energy Absorption/Peak Current Capability

Energy dissipated within the ML is calculated by multiplying the clamping voltage, transient current and transient duration. An important advantage of the multilayer is its interdigitated electrode construction within the mass of dielectric material. This results in excellent current distribution and the peak temperature per energy absorbed is very low. The matrix of semiconducting grains combine to absorb and distribute transient energy (heat) (Figure 11). This dramatically reduces peak temperature; thermal stresses and enhances device reliability.

As a measure of the device capability in energy and peak current handling, the V26MLA1206A part was tested with multiple pulses at its peak current rating (150A , $8/20\mu\text{s}$). At the end of the test, 10,000 pulses later, the device voltage characteristics are still well within specification (Figure 13).

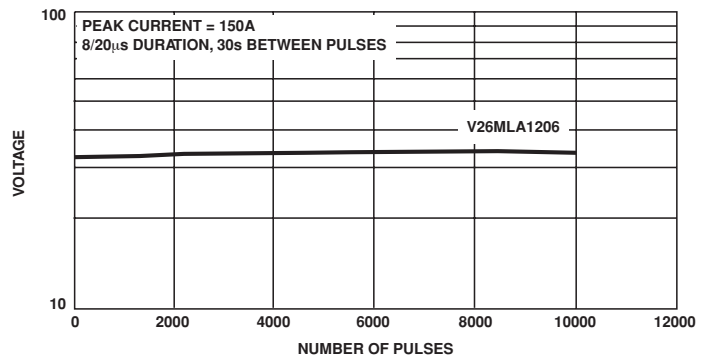

FIGURE 13. REPETITIVE PULSE CAPABILITY

RoHS ML Varistor Series

Soldering Recommendations

Lead (Pb) Soldering Recommendations

The principal techniques used for the soldering of components in surface mount technology are IR Re-flow & Wave soldering. Typical profiles are shown in Figures 14 & 15

The termination options available for each solder technique are:

Reflow	Wave
1. Nickel Barrier (preferred)	1. Nickel Barrier (preferred)
2. Silver/Platinum	2. Silver/Palladium

The recommended solder for the ML suppressor is a 62/36/2 (Sn/Pb/Ag), 60/40 (Sn/Pb) or 63/37 (Sn/Pb). Littelfuse also recommends an RMA solder flux.

Wave soldering is the most strenuous of the processes. To avoid the possibility of generating stresses due to thermal shock, a preheat stage in the soldering process is recommended, and the peak temperature of the solder process should be rigidly controlled.

When using a reflow process, care should be taken to ensure that the ML chip is not subjected to a thermal gradient steeper than 4 degrees per second; the ideal gradient being 2 degrees per second. During the soldering process, preheating to within 100 degrees of the solder's peak temperature is essential to minimize thermal shock.

Once the soldering process has been completed, it is still necessary to ensure that any further thermal shocks are avoided. One possible cause of thermal shock is hot printed circuit boards being removed from the solder process and subjected to cleaning solvents at room temperature. The boards must be allowed to cool gradually to less than 50°C before cleaning.

Lead-Free (Pb-free) Soldering Recommendations

Littelfuse offers the Nickel-Barrier termination finish for the optimum Pb-free solder performance.

The preferred solder is 96.5/3.0/0.5 (SnAgCu) with an RMA flux, but there is a wide selection of pastes & fluxes available with which the nickel barrier parts should be compatible.

The reflow profile must be constrained by maximums shown in Figure 16. For Pb-free Wave soldering, Figure 15 still applies.

Note: the Pb-free paste, flux & profile were used for evaluation purposes by Littelfuse, based upon industry standards & practices. There are multiple choices of all three available, it is advised that the customer explores the optimum combination for their process as processes vary considerably from site to site.

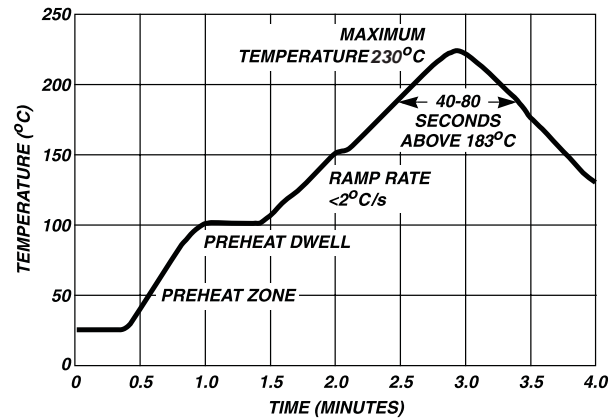

FIGURE 14. REFLOW SOLDER PROFILE

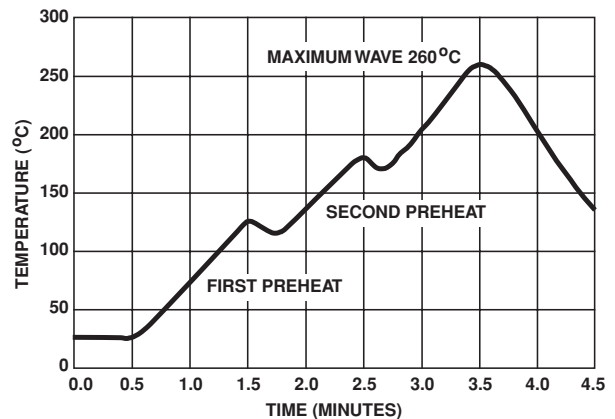

FIGURE 15. WAVE SOLDER PROFILE

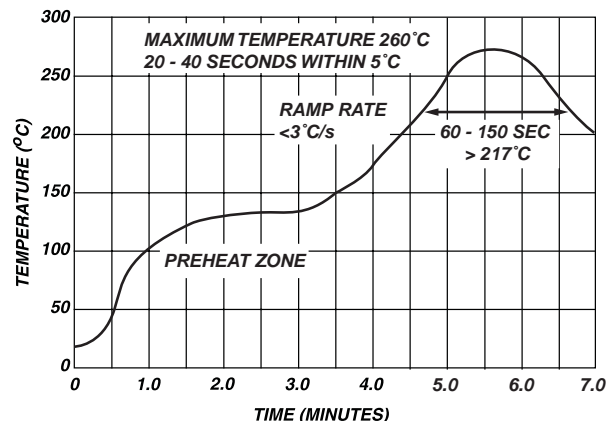

FIGURE 16. LEAD-FREE RE-FLOW SOLDER PROFILE

Surface Mount Varistors

Multilayer Transient Voltage Surge Suppressors

RoHS ML Varistor Series

Recommended Pad Outline

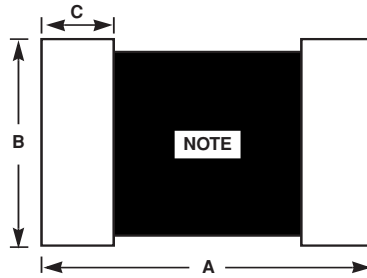

NOTE: Avoid metal runs in this area.

TABLE 1: PAD LAYOUT DIMENSIONS

DIMENSION	PAD SIZE									
	1210 SIZE DEVICE		1206 SIZE DEVICE		0805 SIZE DEVICE		0603 SIZE DEVICE		0402 SIZE DEVICE	
	IN	MM	IN	MM	IN	MM	IN	MM	IN	MM
A	0.160	4.06	0.160	4.06	0.120	3.05	0.100	2.54	0.067	1.70
B	0.100	2.54	0.065	1.65	0.050	1.27	0.030	0.76	0.020	0.51
C	0.040	1.02	0.040	1.02	0.040	1.02	0.035	0.89	0.024	0.61

Surface Mount Varistors

Multilayer Transient Voltage Surge Suppressors

RoHS ML Varistor Series

Mechanical Dimensions

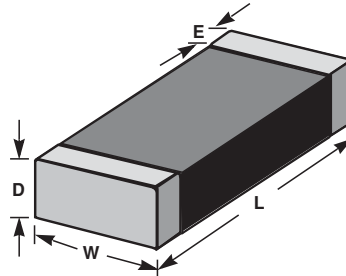

3
SURFACE MOUNT
VARISTORS

DIMENSION	CHIP SIZE									
	1210		1206		0805		0603		0402	
	IN	MM	IN	MM	IN	MM	IN	MM	IN	MM
D Max.	0.113	2.87	0.071	1.80	0.043	1.10	0.035	0.90	0.024	0.90
E	0.02 ±0.01	0.50 ±0.25	0.02 ±0.01	0.50 ±0.25	0.02 ± 0.01	0.50 ± 0.25	0.015 ±0.008	0.4 ±0.2	0.010 ±0.006	0.25 ±0.15
L	0.125 ±0.012	3.20 ±0.30	0.125 ±0.012	3.20 ±0.30	0.079 ±0.008	2.01 ±0.20	0.063 ±0.006	1.6 ±0.15	0.039 ±0.004	1.0 ±0.1
W	0.10 ±0.012	2.54 ±0.30	0.06 ±0.011	1.60 ±0.28	0.049 ±0.008	1.25 ±0.20	0.032 ±0.06	0.8 ±0.15	0.020 ±0.004	0.5 ±0.1

Ordering Information

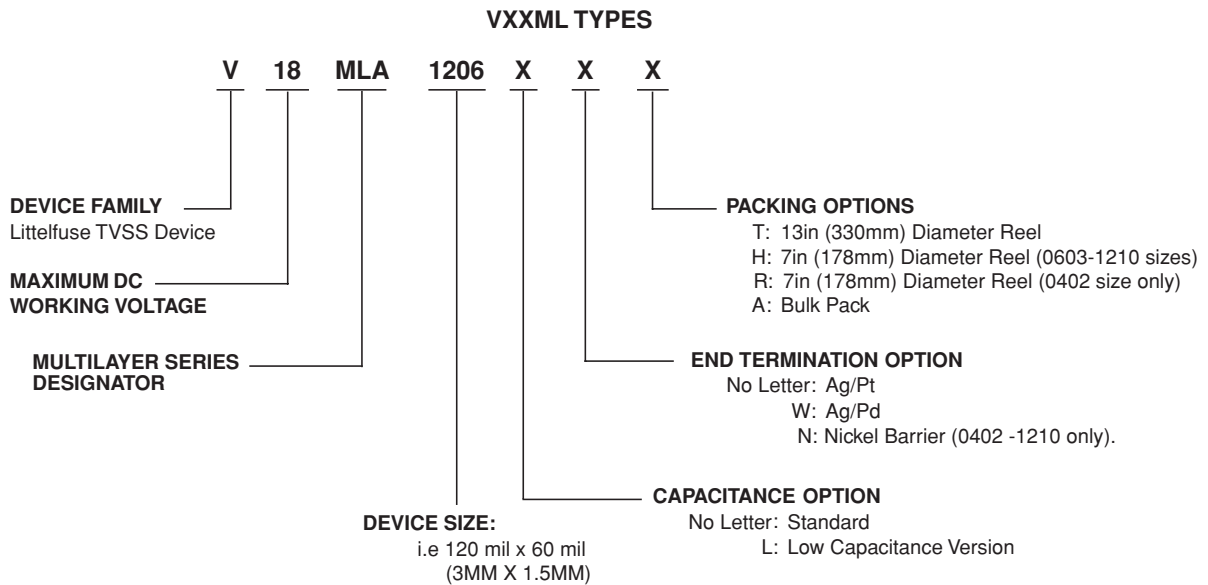

Standard Shipping Quantities

DEVICE SIZE	"13" INCH REEL ("T" OPTION)	"7" INCH REEL ("H" OPTION)	BULK PACK ("A" OPTION)
1210	8,000	2,000	2500
1206	10,000	2,500	2500
0805	10,000	2,500	2500
0603	10,000	2,500	2500
0402	N/A	10,000	N/A

Surface Mount Varistors

Multilayer Transient Voltage Surge Suppressors

RoHS ML Varistor Series

Tape and Reel Specifications

- Conforms to EIA - 481-1, Revision A
- Can be supplied to IEC Publication 286 - 3

SYMBOL	DESCRIPTION	DIMENSIONS IN MILLIMETERS	
		0402 Size	0603, 0805, 1206 & 1210 Sizes
A ₀	Width of Cavity	Dependent on Chip Size to Minimize Rotation.	
B ₀	Length of Cavity	Dependent on Chip Size to Minimize Rotation.	
K ₀	Depth of Cavity	Dependent on Chip Size to Minimize Rotation.	
W	Width of Tape	8 ±0.2	
F	Distance Between Drive Hole Centers and Cavity Centers	3.5 ±0.05	
E	Distance Between Drive Hole Centers and Tape Edge	1.75 ±0.1	
P ₁	Distance Between Cavity Centers	2±0.05	4 ±0.1
P ₂	Axial Drive Distance Between Drive Hole Centers & Cavity Centers	2 ±0.1	
P ₀	Axial Drive Distance Between Drive Hole Centers	4 ±0.1	
D ₀	Drive Hole Diameter	1.55 ±0.05	
D ₁	Diameter of Cavity Piercing	N/A	1.05 ±0.05
T ₁	Top Tape Thickness	0.1 Max	

